

hanit® CALERO CHILDREN'S BENCH

Lively, trendy, colourful

Our Calero is the eye-catcher of every playground. With its cheeky design, this children's bench puts you in a good mood as soon as you take a look - it's fun to have seat here. Yes, it would fit perfectly in Villa Villekulla. To make the bench even better, we've rounded the edges. The Calero paints a perfect picture in every respect.

Material:

hanit® Recycled Plastic

Surface:

Structured, grained

Dimensions (W x D x H):

150 x 28 x 34 cm

Seat height:

34 cm

Weight:

51 kg

Slats:

3 square profiles 132 x 9 x 9 cm
2 profile reinforced

Advantages:

- No risk of injury from splinters
- Safe thanks to rounded edges
- Harmless according to DIN EN 71-3 (Playground directive)
- Durable and dimensionally stable
- Never paint, varnish or grind again
- No annoying mothballing in winter (weatherproof)
- Fast drying, no water absorption
- Resistant to vandalism

Optional:

- Ground anchor type 1



Blue-Red-Green



Grey-Blue





TECHNICAL DRAWING

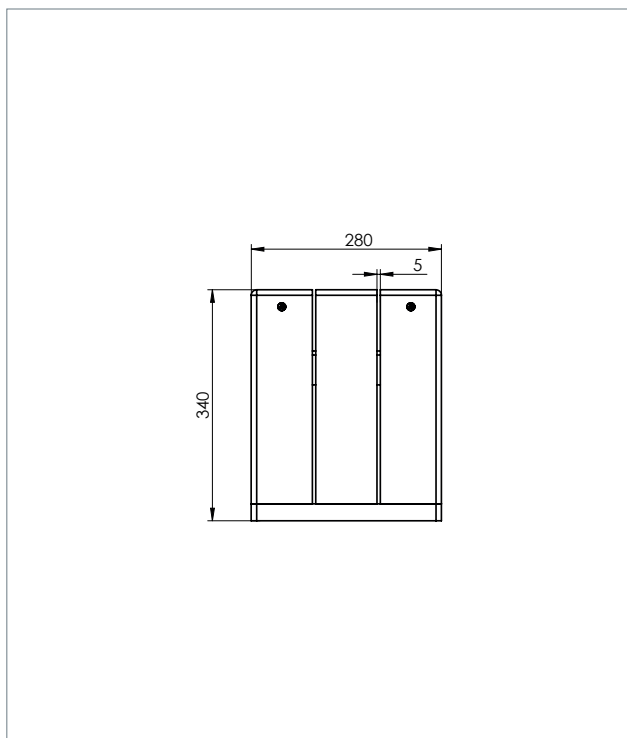

TECHNICAL DATA

Width: 150 cm			
Colour	Dimensions W x D x H (approx. cm)	Weight (approx. kg)	Order No
■ Grey-Blue	150 x 28 x 34	51.0	BK 2 GB 150
■ Blue-Red-Green	150 x 28 x 34	51.0	BK 2 TC 150

Benches and tables are delivered as a kit. Assembly instruction and materials are included.

FURTHER DOCUMENTS PLEASE SEE WWW.HANIT.DE

- » Assembly Instruction
- » Tender Specifications
- » Tests and Certificates
- » General Material Remarks





hanit® CANETTI CHILDREN'S BENCH

Child-friendly seating

The Canetti children's bench is specially designed for kids. With a seat height of 34 cm and wide supporting legs, it's extremely sturdy. There is no back rest so kids can sit and play in all directions and it's available in four colour combinations. The bench is also relatively lightweight and goes perfectly with our Tivoli children's table.

Material:

hanit® Recycled Plastic

Surface:

Structured, grained

Dimensions (W x D x H):

150 x 34 x 34 cm

Seat height:

34 cm

Weight:

29 kg

Slats:

Premium type

3 bench boards 150 x 8 x 4.7 cm

Advantages:

- No risk of injury from splinters
- Safe thanks to rounded edges
- Harmless according to DIN EN 71-3 (Safety of Toys)
- Durable and dimensionally stable
- Never paint, varnish or grind again
- No annoying mothballing in winter (weatherproof)
- Fast drying, no water absorption
- Resistant to vandalism

Optional:

Ground anchor type 1



 *Brown*



 *Grey-Blue*



 *Grey-Green*



 *Grey-Red*





TECHNICAL DRAWING

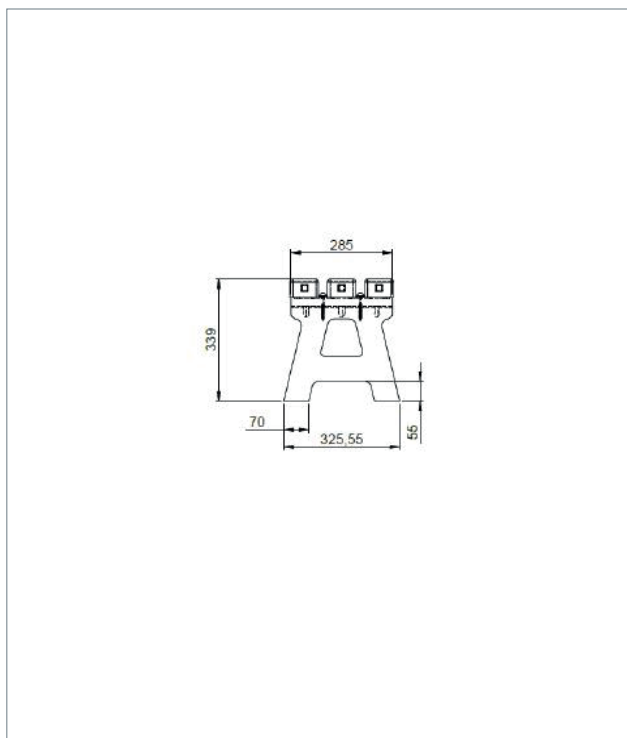

TECHNICAL DATA

Width: 150 cm			
Colour	Dimensions W x D x H (approx. cm)	Weight (approx. kg)	Order No
■ Brown	150 x 34 x 34	29.0	KTA 10 150
■ Grey-Blue	150 x 34 x 34	29.0	KTC 10 150
■ Grey-Green	150 x 34 x 34	29.0	KTB 10 150
■ Grey-Red	150 x 34 x 34	29.0	KTD 10 150

Benches and tables are delivered as a kit. Assembly instruction and materials are included.

FURTHER DOCUMENTS PLEASE SEE WWW.HANIT.DE

- » Assembly Instruction
- » Tender Specifications
- » Tests and Certificates
- » General Material Remarks





hanit® MIRA CHILDREN'S BENCH

For splinter-free little hands

The classic bench, designed especially for kids. Everything about the Mira is child-friendly: every corner is smoothly rounded off and the dimensions are intended for a broad age range. And best of all, there's a matching table to go with it!

Material:

hanit® Recycled Plastic

Surface:

Structured, grained

Dimensions (W x D x H):

200 x 40 x 31 cm

Seat height:

31 cm

Weight:

74 kg

Slats:

Compact type

1 seat board 200 x 40 x 7.5 /6.5 cm

Internal reinforcement

Advantages:

No risk of injury from splinters

Safe thanks to rounded edges

Harmless according to DIN EN 71-3 (Playground directive)

Durable and dimensionally stable

Never paint, varnish or grind again

No annoying mothballing in winter (weatherproof)

Fast drying, no water absorption

Resistant to vandalism

Optional:

Ground anchor type 1



 Brown

DBLBKS40200DEEN0619





TECHNICAL DRAWING

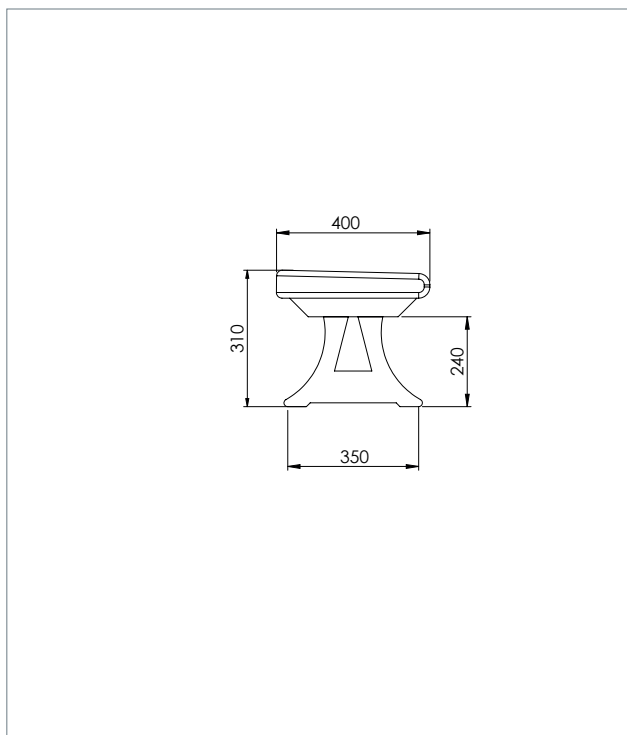

TECHNICAL DATA

Width: 200 cm			
Colour	Dimensions W x D x H (approx. cm)	Weight (approx. kg)	Order No
■ Brown	200 x 40 x 31	74.0	BKS 40 200

Completely assembled on delivery.

FURTHER DOCUMENTS PLEASE SEE WWW.HANIT.DE

- » Assembly Instruction
- » Tender Specifications
- » Tests and Certificates
- » General Material Remarks





hanit® CHILDREN'S BENCH PIPPOLINO

The cheerful bench to play with

It is of course possible to sit still on this bench – but which child does! It is much more fun to draw on the bench. "Pippolino" even has a face to colour on (the chalk can easily be washed off). When toddlers become "wobbly teeth-kids", this bench will still be with them. They grow together, as the bench is adjustable in height.

Material:

hanit® Recycled Plastic

Surface:

Structured, grained

Dimensions (W x D x H):

150 x 68 x 70 cm

Seat height:

Either 25 or 34 cm

Weight:

57 kg

Slats:

Classic type

1 seat board 138 x 19 x 4 cm

1 back board 138 x 17 x 4 cm

Milled reinforcement

Advantages:

For colouring

Height-adjustable

No risk of injury from splinters

Safe thanks to rounded edges

Harmless according to DIN EN 71-3 (Playground directive)

Durable and dimensionally stable

Never paint, varnish or grind again

No annoying mothballing in winter (weatherproof)

Fast drying, no water absorption

Resistant to vandalism

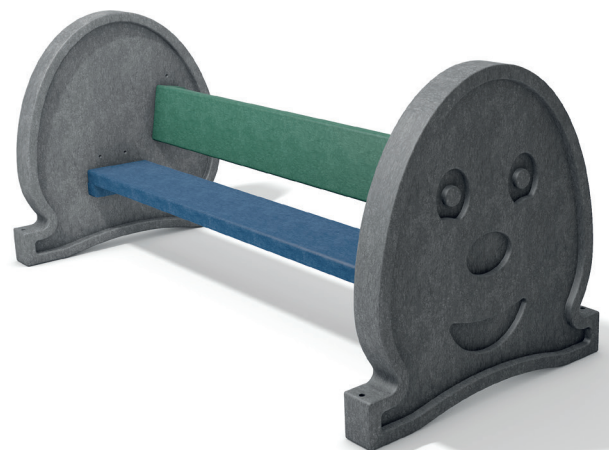

Grey-Blue-Green



www.blauer-engel.de/uz30a

MADE IN GERMANY

HAHN
KUNSTSTOFFE



TECHNICAL DRAWING

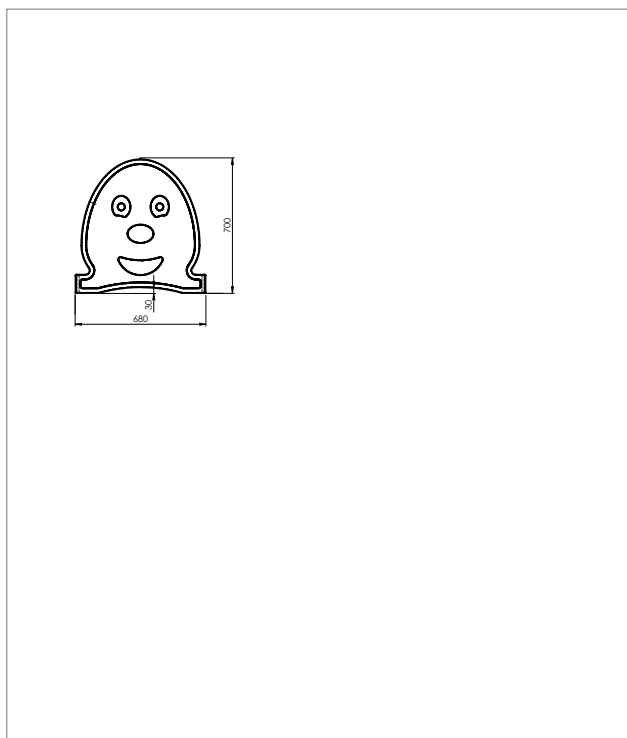

TECHNICAL DATA

Width: 150 cm

Colour	Dimensions W x D x H (approx. cm)	Weight (approx. kg)	Order No
■ Grey-Blue-Green	150 x 68 x 70	57.0	BP 1 GML 150

Benches and tables are delivered as a kit. Assembly instruction and materials are included.

FURTHER DOCUMENTS PLEASE SEE WWW.HANIT.DE

- » Assembly Instruction
- » Tender Specifications
- » Tests and Certificates
- » General Material Remarks





hanit® FORIO CHILDREN'S SET

Tailor-made for kids

If you let kids draw a picnic bench, it will probably look like the Forio. It's the classic shape – just smaller! The table and bench form a sturdy unit that can be used for more than just a picnic bench. Throw a sheet over the Forio and it becomes a cave or tent: great for little kids with big imaginations.

Material:

hanit® Recycled Plastic

Surface:

Structured, grained

Dimensions (W x D x H):

150 x 108 x 57 cm

Seat height:

34 cm

Weight:

80 kg

Slats:

1 table top 150 x 60 x 8 cm
2 bench boards 150 x 19 x 4 cm

Vorteile:

- The perfect play table
- No risk of injury from splinters
- Safe thanks to rounded edges
- Harmless according to DIN EN 71-3 (Playground directive)
- Durable and dimensionally stable
- Never paint, varnish or grind again
- No annoying mothballing in winter (weatherproof)
- Fast drying, no water absorption
- Resistant to vandalism

Optional:

Ground anchor type 3



■ Brown



■ Grey-Blue



■ Grey-Green



■ Grey-Red





TECHNICAL DRAWING

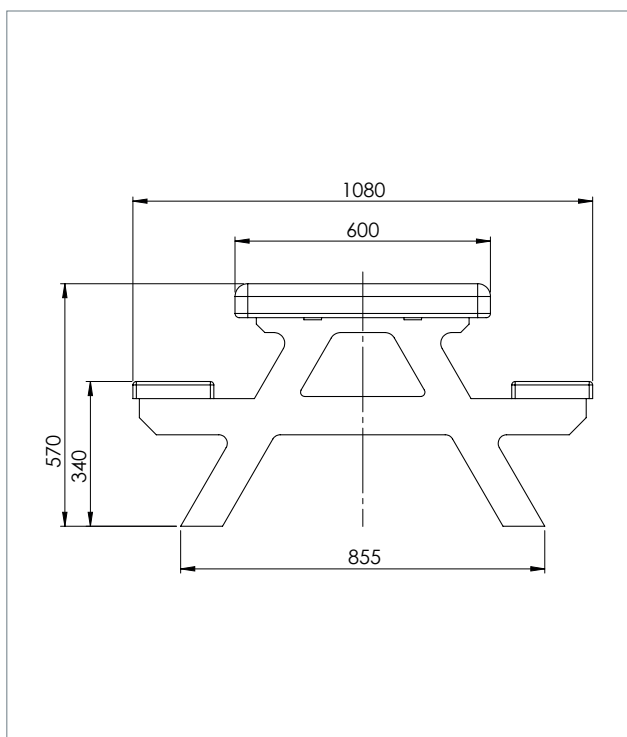

TECHNICAL DATA

Width: 150 cm			
Colour	Dimensions W x D x H (approx. cm)	Weight (approx. kg)	Order No
■ Brown	150 x 108 x 57	80.0	SBA 40 150
■ Grey-Blue	150 x 108 x 57	80.0	SLA 40 150
■ Grey-Green	150 x 108 x 57	80.0	SMA 40 150
■ Grey-Red	150 x 108 x 57	80.0	SRA 40 150

Benches and tables are delivered as a kit. Assembly instruction and materials are included.

FURTHER DOCUMENTS PLEASE SEE WWW.HANIT.DE

- » Assembly Instruction
- » Tender Specifications
- » Tests and Certificates
- » General Material Remarks





hanit® CALERO CHILDREN'S TABLE

So colourful!

Make it a matching set with the Calero children's table. It's even more eye-catching than the bench because it has two additional coloured planks. As well as being colourful, it is as robust and durable as all of our other hanit® products. Last but not least, safety is given top priority and just like the bench, the edges have been rounded.

Material:

hanit® Recycled Plastic

Surface:

Structured, grained

Dimensions (W x D x H):

150 x 47 x 57 cm

Table height:

57 cm

Weight:

102 kg

Slats:

5 square profiles 132 x 9 x 9 cm
3 profiles reinforced

Advantages:

- No risk of injury from splinters
- Safe thanks to rounded edges
- Harmless according to DIN EN 71-3 (Playground directive)
- Durable and dimensionally stable
- Never paint, varnish or grind again
- No annoying mothballing in winter (weatherproof)
- Fast drying, no water absorption
- Resistant to vandalism

Optional:

Ground anchor type 2



Blue-Red-Green

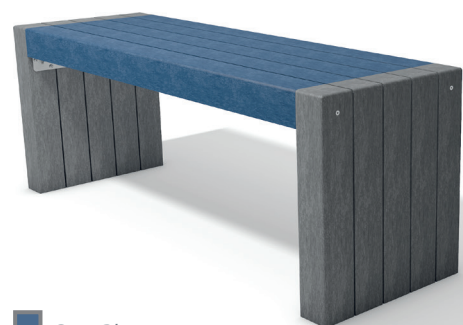

Grey-Blue

DBLCAKLTGDEEN0619





TECHNICAL DRAWING

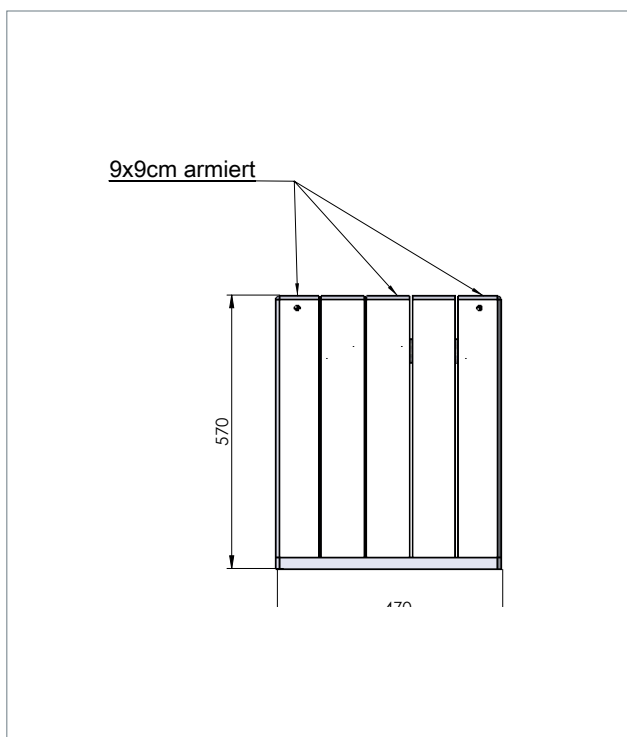

TECHNICAL DATA

Width: 150 cm			
Colour	Dimensions W x D x H (approx. cm)	Weight (approx. kg)	Order No
■ Grey-Blue	150 x 47 x 57	102.0	TK 2 GB 150
■ Blue-Red-Green	150 x 47 x 57	102.0	TK 2 TC 150

Benches and tables are delivered as a kit. Assembly instruction and materials are included.

FURTHER DOCUMENTS PLEASE SEE WWW.HANIT.DE

- » Assembly Instruction
- » Tender Specifications
- » Tests and Certificates
- » General Material Remarks





hanit® MIRA CHILDREN'S TABLE

The long-lasting little one

This cute, fun and child-friendly table does a great job in almost any situation. At only 45 cm high, it has a very low centre of gravity and appears to be even more stable than its grown up counterpart. Strong, durable and sturdy, this is a great addition to the Mira family.

Material:

hanit® Recycled Plastic

Surface:

Structured, grained

Dimensions (W x D x H):

approx. 200 x 82 x 59 cm

Table height:

59 cm

Weight:

131 kg

Slats:

Compact type

2 table boards 200 x 40 x 7.5 /6.5 cm

Internal reinforcement

Advantages:

- No risk of injury from splinters
- Safe thanks to rounded edges
- Harmless according to DIN EN 71-3 (Playground directive)
- Durable and dimensionally stable
- Never paint, varnish or grind again
- No annoying mothballing in winter (weatherproof)
- Fast drying, no water absorption
- Resistant to vandalism

Optional:

- Ground anchor type 1



 Brown





TECHNICAL DRAWING

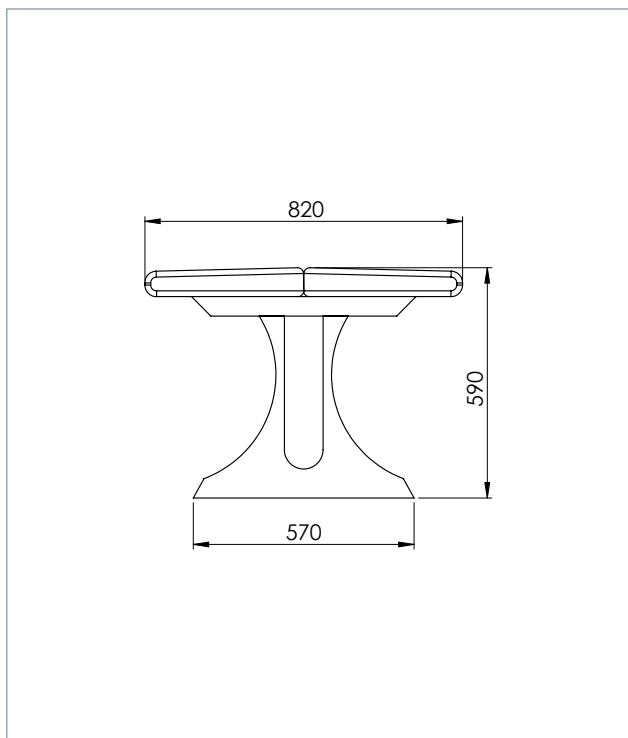

TECHNICAL DATA

Width: 200 cm			
Colour	Dimensions W x D x H (approx. cm)	Weight (approx. kg)	Order No
■ Brown	200 x 82 x 59	131.0	TKS 40 200

Completely assembled on delivery.

FURTHER DOCUMENTS PLEASE SEE WWW.HANIT.DE

- » Tender Specifications
- » Tests and Certificates
- » General Material Remarks



hanit® TIVOLI CHILDREN'S TABLE

Specially made for kids

The Tivoli children's table is a perfect match for the Canetti children's bench. They're made from the same hanit® material, in the same colour combinations and they fit together nicely. And thanks to being so sturdy and tough, the Tivoli can pass one of nature's toughest tests –kids at play!

Material:

hanit® Recycled Plastic

Surface:

Structured, grained

Dimensions (W x D x H):

150 x 60 x 57 cm

Table height:

57 cm

Weight:

80 kg

Slats:

Premium type

5 table boards 150 x 10 x 4.7 cm

Internal reinforcement

Advantages:

No risk of injury from splinters

Safe thanks to rounded edges

Harmless according to DIN EN 71-3 (Playground directive)

Durable and dimensionally stable

Never paint, varnish or grind again

No annoying mothballing in winter (weatherproof)

Fast drying, no water absorption

Resistant to vandalism

Optional:

Ground anchor type 1



 *Brown*



 *Grey-Blue*



 *Grey-Green*



 *Grey-Red*





TECHNICAL DRAWING

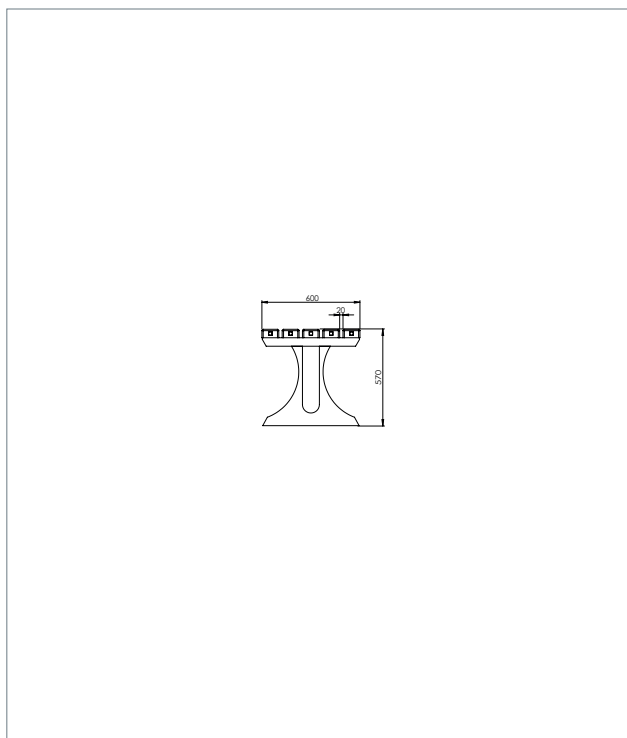

TECHNICAL DATA

Width: 150 cm			
Colour	Dimensions W x D x H (approx. cm)	Weight (approx. kg)	Order No
■ Brown	150 x 60 x 57	80.0	TTA 10 150
■ Grey-Blue	150 x 60 x 57	80.0	TTC 10 150
■ Grey-Green	150 x 60 x 57	80.0	TTB 10 150
■ Grey-Red	150 x 60 x 57	80.0	TTD 10 150

Benches and tables are delivered as a kit. Assembly instruction and materials are included.

FURTHER DOCUMENTS PLEASE SEE WWW.HANIT.DE

- » Assembly Instruction
- » Tender Specifications
- » Tests and Certificates
- » General Material Remarks





hanit® DAHNA SANDBOX

Circle in the Square

Are those tree trunks? The look of the palisades gives Dahna the appearance of belonging in a forest playground. This sandbox with seating wins you over not only through its natural shape, the simplified assembly as well as the colours will please children right away.

Material:

hanit® Recycled Plastic

Surface:

Structured, grained

Dimensions (W x D x H):

200 x 200 x 28 cm

Weight:

185 kg

Profiles:

2 side profiles each Ø 12 cm

2 seat boards 4 x 17 cm

Version:

Without bottom

Delivery as construction kit

Advantages:

No risk of injury from splinters

Safe thanks to rounded edges

Harmless according to DIN EN 71-3 (Playground directive)

Durable and dimensionally stable

Never paint, varnish or grind again

No annoying mothballing in winter (weatherproof)

Simple mounting



Grey-Blue-Green





TECHNICAL DATA

Dahna sandbox

Colour	Dimensions W x D x H (approx. cm)	Weight (approx. kg)	Order No
■ Grey-Blue-Green	200 x 200 x 28	185.0	SD 1 GML 200

Side profile: each side 2 round posts Ø 12 cm . Seat rest: 4 x 17 cm. Delivered as a kit excluding base.

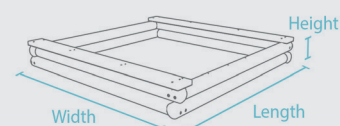

FURTHER DOCUMENTS PLEASE SEE WWW.HANIT.DE

- » Installation Recommendation
- » Tender Specifications
- » Tests and Certificates
- » General Material Remarks

HAHN
KUNSTSTOFFE



hanit® GOBI SANDBOX

Big fun, large or small

The Gobi is available in large or small. The small version is compact enough to fit very small gardens, decks or even balconies. The large one is designed for playgrounds. You choose the size, the Gobi takes care of the rest.

Material:

hanit® Recycled Plastic

Surface:

Structured, grained

Dimensions (W x D x H):

120 x 120 x 31 cm and 240 x 240 x 31 cm

Weight:

71 kg and 142 kg

Profiles:

2 side profiles each 3.8 x 13 cm

4 seat boards 4 x 14 cm

Version:

Without bottom

Delivery as construction kit

Advantages:

No risk of injury from splinters

Safe thanks to rounded edges

Harmless according to DIN EN 71-3 (Playground directive)

Durable and dimensionally stable

Never paint, varnish or grind again

No annoying mothballing in winter (weatherproof)

Simple mounting

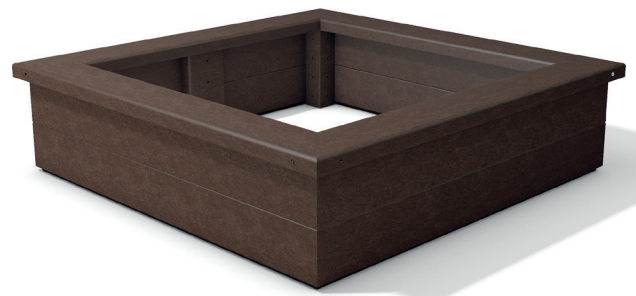

 Brown





TECHNICAL DATA

Gobi 1 sandbox

Colour	Dimensions W x L x H (approx. cm)	Weight (approx. kg)	Order No
■ Brown	120 x 120 x 31	71.0	SV 120 120

Gobi 2 sandbox

Colour	Dimensions W x L x H (approx. cm)	Weight (approx. kg)	Order No
■ Brown	240 x 240 x 31	142.0	SV 240 240

Side profile: 3.8 x 13 cm. Seat rest: 4 x 14 cm. Dimensions: Outside edge of seat rest. Delivered as a kit excluding base. Other dimensions available on request.

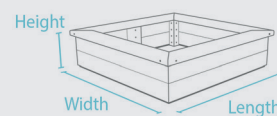
FURTHER DOCUMENTS PLEASE SEE WWW.HANIT.DE

- » Installation Recommendation
- » Tender Specifications
- » Tests and Certificates
- » General Material Remarks

HAHN
KUNSTSTOFFE



hanit® KALAHARI SANDBOX

Fun in every corner

The hexagonal Kalahari sandbox is available in two sizes. The wide edge provides lots of sitting space and every young trailblazer can find a spot for digging and building. Attractive, splinter-free and non-toxic.

Material:

hanit® Recycled Plastic

Surface:

Structured, grained

Dimensions (Ø x H):

175 x 30 cm und 240 x 30 cm

Weight:

72 kg und 108 kg

Profiles:

2 side profiles each 3.8 x 13 cm

4 seat boards 4 x 14 cm

Version:

Without bottom

Delivery as construction kit

Advantages:

No risk of injury from splinters

Safe thanks to rounded edges

Harmless according to DIN EN 71-3 (Playground directive)

Durable and dimensionally stable

Never paint, varnish or grind again

No annoying mothballing in winter (weatherproof)

Simple mounting



 *Brown*

DBLKALAHADEN0619





TECHNICAL DATA

Kalahari 1 sandbox

Colour	Dimensions \varnothing x H (approx. cm)	Weight (approx. kg)	Order No
■ Brown	175 x 30	72.0	50 160 030

Kalahari 2 sandbox

Colour	Dimensions \varnothing x H (approx. cm)	Weight (approx. kg)	Order No
■ Brown	240 x 30	108.0	50 240 030

Side profile: 3.8 x 13 cm. Seat rest: 4 x 14 cm. Dimensions: Outside edge of seat rest. Delivered as a kit excluding base. Other dimensions available on request.

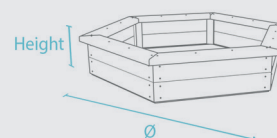
FURTHER DOCUMENTS PLEASE SEE WWW.HANIT.DE

- » Installation Recommendation
- » Tender Specifications
- » Tests and Certificates
- » General Material Remarks

HAHN
KUNSTSTOFFE



hanit® LUT SANDBOX

Set sail in the sand

The Lut is our most distinctive sandbox. Its boat-shape design is sure to be the eye-catcher of the playground – guaranteed to have kids eager to jump in and set sail in the sand! The Lut is completely pre-assembled on delivery and available in four colour combinations.

Material:

hanit® Recycled Plastic

Surface:

Structured, grained

Dimensions (W x D x H):

105 x 285 x 30 cm

Weight:

150 kg

Profiles:

Side profiles 3.0 x 12.5 cm

Seat boards 4 x 10/19 cm

Version:

Boat-shaped

Without bottom

Delivery completely assembled

Vorteile:

Playful boat shape

No risk of injury from splinters

Safe thanks to rounded edges

Harmless according to DIN EN 71-3 (Playground directive)

Durable and dimensionally stable

Never paint, varnish or grind again

No annoying mothballing in winter (weatherproof)

Simple mounting

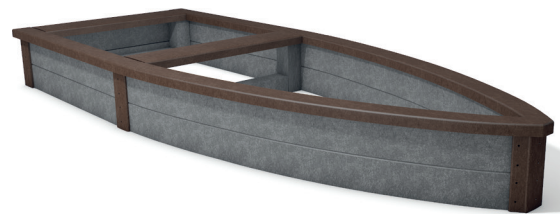

Grey-Brown

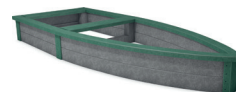

Grey-Green

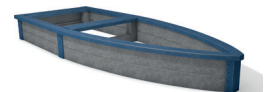

Grey-Blue

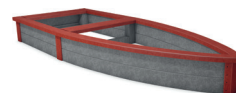

Grey-Red





TECHNICAL DATA

Colour	Dimensions W x L x H (approx. cm)	Weight (approx. kg)	Order No
■ Grey-Brown	105 x 285 x 30	150.0	SG 285 100
■ Grey-Green	105 x 285 x 30	150.0	SM 285 100
■ Grey-Blue	105 x 285 x 30	150.0	SL 285 100
■ Grey-Red	105 x 285 x 30	150.0	SR 285 100

Side profile: 3.0 x 12.5 cm. Seat rest: 4 x 10/19 cm. Dimensions: Outside edge of seat rest. Completely assembled on delivery, excluding base. Other dimensions available on request.

 A technical line drawing of the boat-shaped sandbox. It shows the side profile with three dimension lines: 'Length' along the top edge, 'Width' across the front, and 'Height' at the side.

FURTHER DOCUMENTS PLEASE SEE WWW.HANIT.DE

- » Installation Recommendation
- » Tender Specifications
- » Tests and Certificates
- » General Material Remarks





hanit® MOJAVE SANDBOX

For endless play in an octagonal shape

The octagonal shape of the Mojave is what sets it apart. It gives exciting new opportunities for playground design and is available in three sizes. It is lower than most sandboxes so kids can easily run in, out, over and around. Make the Mojave the focal point of your new playground.

Material:

hanit® Recycled Plastic

Surface:

Structured, grained

Dimensions (Ø x H):

240 x 21 cm, 300 x 21 cm and 400 x 21 cm

Weight:

220 kg, 275 kg and 365 kg

Profiles:

1 side profile each 15.5 x 21 cm

Version:

Without bottom

Delivery as construction kit

Advantages:

No risk of injury from splinters

Safe thanks to rounded edges

Harmless according to DIN EN 71-3 (Playground directive)

Durable and dimensionally stable

Never paint, varnish or grind again

No annoying mothballing in winter (weatherproof)

Simple mounting



 Brown





TECHNICAL DATA

Mojave 1 sandbox

Colour	Dimensions \emptyset x H (approx. cm)	Weight (approx. kg)	Order No
■ Brown	240 x 21	220.0	SB 240 021

Mojave 2 sandbox

Colour	Dimensions \emptyset x H (approx. cm)	Weight (approx. kg)	Order No
■ Brown	300 x 21	275.0	SB 300 021

Mojave 3 sandbox

Colour	Dimensions \emptyset x H (approx. cm)	Weight (approx. kg)	Order No
■ Brown	400 x 21	365.0	SB 400 021

Side profile: 15.5 x 21 cm. Dimensions: Outside edge. Delivered as a kit excluding base.
Other dimensions available on request.

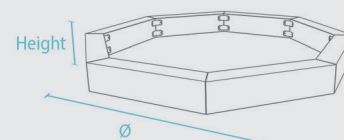

FURTHER DOCUMENTS PLEASE SEE WWW.HANIT.DE

- » Installation Recommendation
- » Tender Specifications
- » Tests and Certificates
- » General Material Remarks

HAHN
KUNSTSTOFFE



hanit® NAMIB SANDBOX

Simple, square and practical

The Namib is the classic sandbox: square, a solid base and a wide sitting edge. There's lots of space for kids to play and let their imaginations run free. There's no need to worry about splinters, rusty edges or even harmful chemicals – hanit® is completely non-toxic and free from hazardous preservatives. Available in four sizes.

Material:

hanit® Recycled Plastic

Surface:

Structured, grained

Dimensions (W x L):

200 x 200 cm, 300 x 300 cm, 400 x 400 cm and 500 x 500 cm

Height:

31 cm

Weight:

250 kg, 360 kg, 480 kg and 600 kg

Profiles:

2 side profiles each 9 x 9 cm

4 seat boards 4 x 19 cm

Version:

Without bottom

Delivery as construction kit

Advantages:

No risk of injury from splinters

Safe thanks to rounded edges

Harmless according to DIN EN 71-3 (Playground directive)

Durable and dimensionally stable

Never paint, varnish or grind again

No annoying mothballing in winter (weatherproof)

Simple mounting



 Brown





TECHNICAL DATA

Namib 1 sandbox			
Colour	Dimensions W x L x H (approx. cm)	Weight (approx. kg)	Order No
■ Brown	200 x 200 x 31	250.0	SR 200 200
Namib 2 sandbox			
Colour	Dimensions W x L x H (approx. cm)	Weight (approx. kg)	Order No
■ Brown	300 x 300 x 31	360.0	SR 300 300
Namib 3 sandbox			
Colour	Dimensions W x L x H (approx. cm)	Weight (approx. kg)	Order No
■ Brown	400 x 400 x 31	480.0	SR 400 400
Namib 4 sandbox			
Colour	Dimensions W x L x H (approx. cm)	Weight (approx. kg)	Order No
■ Brown	500 x 500 x 31	600.0	SR 500 500

Side profile: 9 x 9 cm. Seat rest: 4 x 19 cm. Dimensions: Outside edge of seat rest. Delivered as a kit excluding base. Other dimensions available on request.

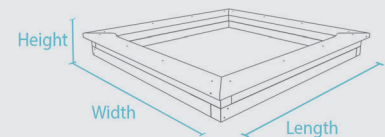

FURTHER DOCUMENTS PLEASE SEE WWW.HANIT.DE

- » Installation Recommendation
- » Tender Specifications
- » Tests and Certificates
- » General Material Remarks





hanit® SAHARA SANDBOX

Wonderland for the imagination

The Sahara sandbox is available in two sizes and four colour combinations. It's a great example of why hanit® has so many advantages over wood, concrete or steel: it doesn't rot or splinter; it's weather-resistant and UV-resistant; it needs little or no maintenance and it's perfect for playtime!

Material:

hanit® Recycled Plastic

Surface:

Structured, grained

Dimensions (W x L x H):

200 x 200 x 27 cm and 300 x 300 x 27 cm

Weight:

195 kg and 295 kg

Profiles:

7 side profiles each 8 x 23 cm
4 seat boards 4 x 19 cm

Version:

Without bottom
Delivery as construction kit

Advantages:

- No risk of injury from splinters
- Safe thanks to rounded edges
- Harmless according to DIN EN 71-3 (Playground directive)
- Durable and dimensionally stable
- Never paint, varnish or grind again
- No annoying mothballing in winter (weatherproof)
- Simple mounting

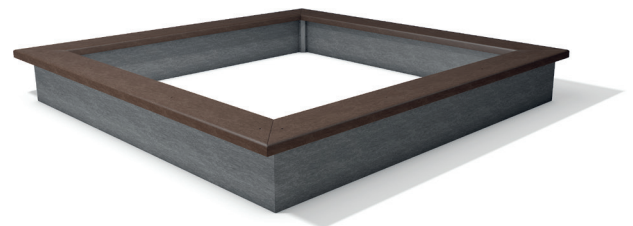

Grey-Brown



Grey-Blue

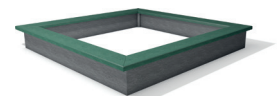

Grey-Green



Grey-Red

DBLSAHARADEEN0619





TECHNICAL DATA

Sahara 1 sandbox

Colour	Dimensions W x L x H (approx. cm)	Weight (approx. kg)	Order No
■ Grey-Brown	200 x 200 x 27	195.0	WG 200 200
■ Grey-Blue	200 x 200 x 27	195.0	WL 200 200
■ Grey-Green	200 x 200 x 27	195.0	WM 200 200
■ Grey-Red	200 x 200 x 27	195.0	WR 200 200

Sahara 2 sandbox

Colour	Dimensions W x L x H (approx. cm)	Weight (approx. kg)	Order No
■ Grey-Brown	300 x 300 x 27	295.0	WG 300 300
■ Grey-Blue	300 x 300 x 27	295.0	WL 300 300
■ Grey-Green	300 x 300 x 27	295.0	WM 300 300
■ Grey-Red	300 x 300 x 27	295.0	WR 300 300

Side profile: 8 x 23 cm. Seat rest: 4 x 19 cm. Dimensions: Outside edge of seat rest. Delivered as a kit excluding base. Other dimensions available on request.

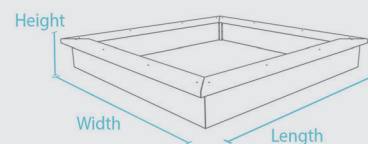

FURTHER DOCUMENTS PLEASE SEE WWW.HANIT.DE

- » Installation Recommendation
- » Tender Specifications
- » Tests and Certificates
- » General Material Remarks

HAHN
KUNSTSTOFFE



hanit® MUD TABLE

Tailor-made for kids

Kids love playing with sand and water but when you mix this combination with wood, the fun doesn't last for long. Wood weathered quickly and splintered. hanit® mud tables are much more durable. They won't weather, splinter or rot. What's more, our tables are easy to assemble and have endless combinations.

Material:

hanit® Recycled Plastic

Surface:

Structured, grained

Dimension (W x L):

60 x 150 cm

Heights (from top edge to floor):

- End table - 32/32 cm
- Flow element 1 - 45/55 cm
- Flow element 2 - 65/75 cm
- Flow element 3 - 85/95 cm

Weights:

55 kg, 62 kg, 70 kg and 77 kg

Version:

Legs to be embedded to the ground

Delivery as construction kit

Accessories (optional):

Pump platform

Advantages:

- Playing in mud with system
- No risk of injury from splinters
- Safe thanks to rounded edges
- Harmless according to DIN EN 71-3 (Playground directive)
- Durable and dimensionally stable
- Never paint, varnish or grind again
- Weather-proof and rot-free
- Simple mounting
- Few individual parts available



 Green-Brown

DBLMATSCHTDEEN0720



www.blauer-engel.de/uz30a

 **MADE IN GERMANY**

HAHN
KUNSTSTOFFE



TECHNICAL DATA

Flow element 1			
Colour	Dimensions W x L x H (approx. cm)	Weight (approx. kg)	Order No
■ Green-Brown	78 x 150 x 42/52	62.0	MBM 55 150
Flow element 2			
Colour	Dimensions W x L x H (approx. cm)	Weight (approx. kg)	Order No
■ Green-Brown	78 x 150 x 62/72	70.0	MBM 75 150
Flow element 3			
Colour	Dimensions W x L x H (approx. cm)	Weight (approx. kg)	Order No
■ Green-Brown	78 x 150 x 82/92	77.0	MBM 95 150
End table			
Colour	Dimensions W x L x H (approx. cm)	Weight (approx. kg)	Order No
■ Green-Brown	78 x 150 x 29/29	55.0	MBM 40 150
Water pump stand			
Colour	Dimensions W x L x H (approx. cm)	Weight (approx. kg)	Order No
■ Brown	100 x 100 x 22	80.0	MBB 20 100

Legs to be embedded in the ground. Height from upper edge of soil. Delivered as a kit.
Other sizes and colours available on request.

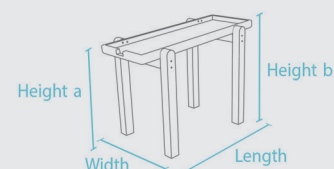

FURTHER DOCUMENTS PLEASE SEE WWW.HANIT.DE

- » Installation Recommendation
- » Tender Specifications
- » Tests and Certificates
- » General Material Remarks





hanit® THAR SANDBOX SYSTEM

An adaptable system for variable spaces

The Thar sandbox system is a highly adaptable assembly kit for creating safe and durable sandboxes. The parts are easy to understand and simple to build. And best of all, connections and fittings are kept out of harm's way: no screws or splinters causing injuries to inquisitive little hands.

Material:

hanit® Recycled Plastic

Surface:

Structured, grained

Dimensions (W x L):

325 x 325 cm, 475 x 475 cm, 625 x 625 cm and 775 x 775 cm

Height:

16 cm

Weight:

358 kg, 572 kg, 708 kg and 890 kg

Profiles:

Standard U-profiles 24 x 16 cm

End piece U-profiles 24 x 16 cm

Version:

Without bottom

Delivery as construction kit

Advantages:

Sandbox construction with system

For solid and uneven surfaces

No risk of injury from splinters

Safe thanks to rounded edges

Harmless according to DIN EN 71-3 (Playground directive)

Durable and dimensionally stable

Never paint, varnish or grind again

No annoying mothballing in winter (weatherproof)

Simple mounting

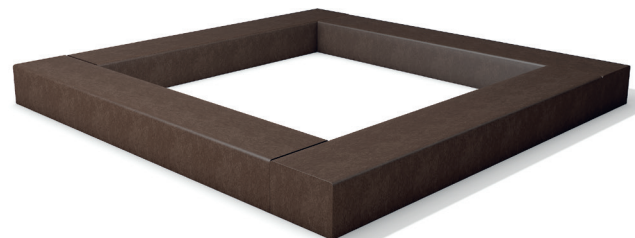

 Brown





TECHNICAL DATA

Thar sandbox system

Colour	Dimensions W x L x H (approx. cm)	Weight (approx. kg)	Order No
■ Brown	325 x 325 x 16	320.0	TBB 325 325
■ Brown	475 x 475 x 16	456.0	TBB 475 475
■ Brown	625 x 625 x 16	609.0	TBB 625 625
■ Brown	775 x 775 x 16	765.0	TBB 775 775

Delivered as a kit excluding base. Other dimensions available on request.

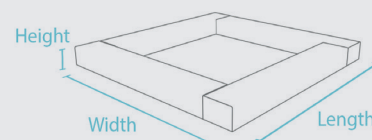

FURTHER DOCUMENTS PLEASE SEE WWW.HANIT.DE

- » Installation Recommendation
- » Tests and Certificates
- » General Material Remarks

HAHN
KUNSTSTOFFE